

MODEL: 3XHWS6030.V31*

Crestline

*ALL ACCESSORIES OPTIONAL

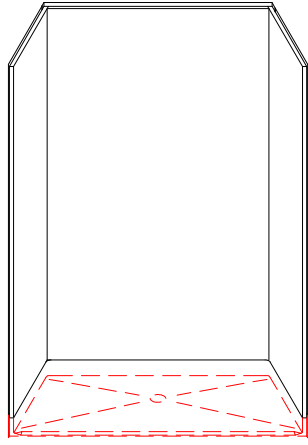

PERSPECTIVE VIEW - N.T.S.
(BASE NOT INCLUDED)

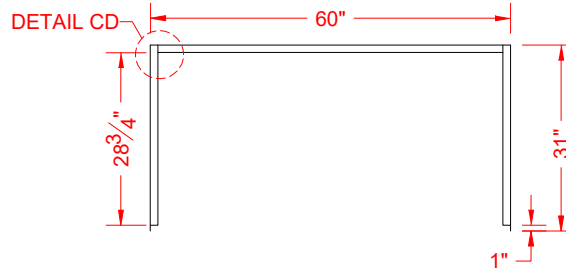

TOP VIEW - SCALE $\frac{3}{8}'' = 1'-0''$

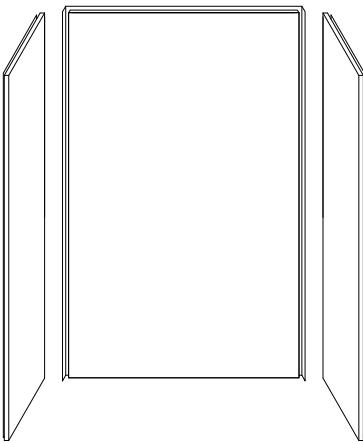

ASSEMBLY VIEW - N.T.S.

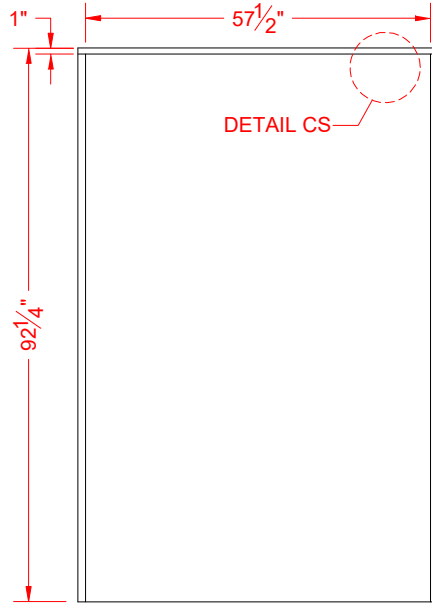

FRONT ELEVATION - SCALE: $\frac{3}{8}'' = 1'-0''$

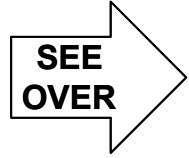

Features:

- Multi-piece gelcoat/fiberglass shower pan wall surround
- High-pressure laminate stone-pattern finish offered in multiple colors
- Integral full wood backing for strength and unlimited accessory placement
- Walls can be trimmed on-site up to 2' to accommodate height restrictions. (XFTK/XFTWC3 recommended when trimmed)

* - SEE BACK FOR DETAIL SECTIONS

PRODUCT SPECIFICATIONS:

- Multi-piece wall surround shall be constructed of gelcoat/fiberglass with full integral plywood backing in the walls
- Rough-In: Stud opening +1/8" to +1/4" Nominal Dimensions.

C.S.I. FORMAT SPECIFICATION TEXT AVAILABLE

PRODUCT INFORMATION:

- Accessories: Polished chrome/satin stainless standard, others available.
- Colors: Available in Beige Limestone, Gray Slate, White Marble & Dark Gray Marble.

OPTIONAL ACCESSORIES:

INSTALLED BY OTHERS:

- Grab bar
- Soap dish
- Mixing valve, pressure-balancing, lever handle, pre-plumbed tee to supply elbow
- Curtain rod brackets
- Flange trim kit

CODES:

- Designed and manufactured in compliance with the following standards and codes:
- CSA B45.5-11 / IAPMO Z124-11
- Plastic Plumbing Fixtures

NOTICE OF LIMITATION:

- Does not meet:
- I.P.C. International Plumbing Code
- U.P.C. Uniform Plumbing Code
- Verify all spatial requirements for mounting and installation before purchasing.
- Warranty is void if more than 2' is trimmed.



We reserve the right to make revisions without notice in the design of fixtures or in packaging unless this right has specifically been waived at the time the order is accepted.

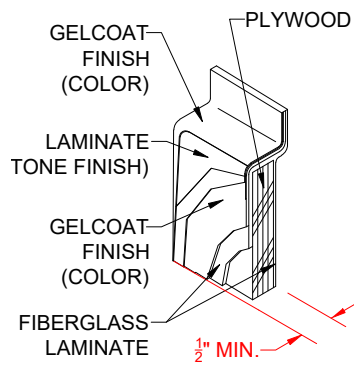

DETAIL CS - SCALE: N.T.S.
CROSS SECTION DETAIL

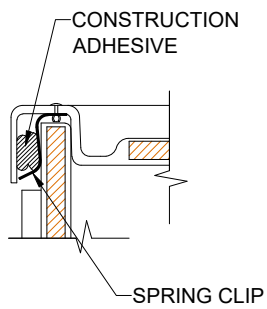

DETAIL CD - SCALE: 3" = 1'-0"
CORNER DETAIL