

MODEL: 4XBTSF6030.V2* L/R

REMODELER

*ALL ACCESSORIES OPTIONAL

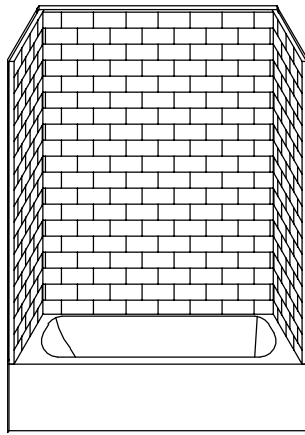

PERSPECTIVE VIEW - N.T.S.
MODEL SHOWN HERE AS:
RIGHT DRAIN

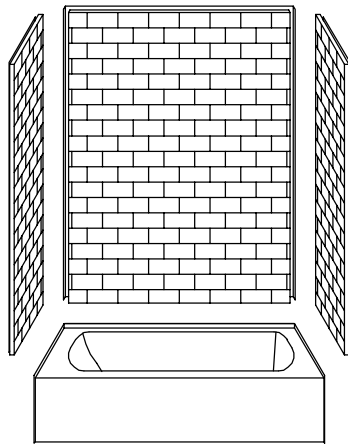

ASSEMBLY VIEW - N.T.S.

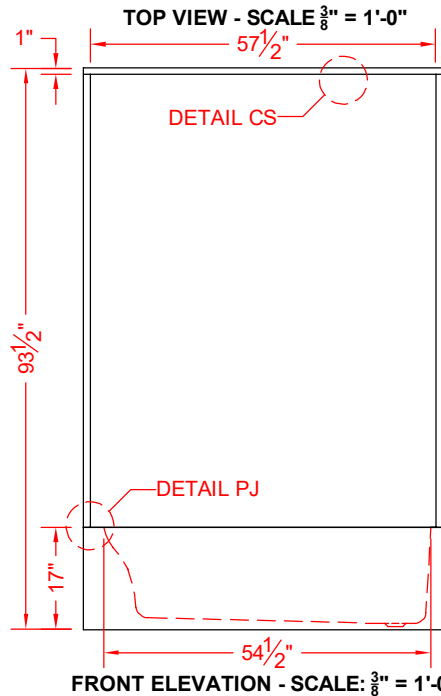
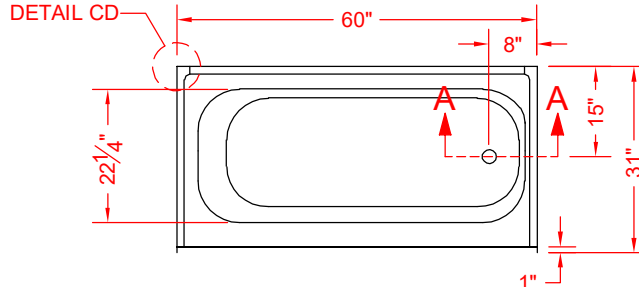

TOP VIEW - SCALE $\frac{3}{8}'' = 1'-0''$

FRONT ELEVATION - SCALE: $\frac{3}{8}'' = 1'-0''$

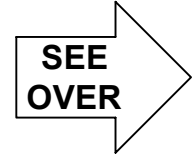

Features:

- Molded, four-piece gelcoat/fiberglass tub/shower module
- "Subway Tile", 4" x 8" simulated tile wall finish, white (standard)
- Integral full wood backing for strength and unlimited accessory placement
- Flat upper back wall to avoid interference for window trim kits, grab bars, etc.

* - SEE BACK FOR DETAIL SECTIONS

PRODUCT SPECIFICATIONS:

- Multi-piece tub/shower module shall be constructed of gelcoat/fiberglass with full integral plywood backing in the walls
 - Door opening: 57-1/2" x 75-1/4"
 - Rough-In: Stud opening +1/4" -0" Nominal Dimensions.
- C.S.I. FORMAT SPECIFICATION TEXT AVAILABLE

PRODUCT INFORMATION:

- Accessories: Factory installed, unless prone to damage during installation/shipping. Polished chrome/satin stainless standard, others available.
- Colors: White as standard, others to match any major fixture manufacturer, also available with sprayable solid surface in many colors

OPTIONAL ACCESSORIES:

INSTALLED BY OTHERS:

- Seat, folding
- Grab bar
- Soap dish
- Mixing valve, pressure-balancing, lever handle, pre-plumbed tee to supply elbow
- Curtain rod brackets
- Curtain and rod
- Flange-window trim kits

CODES:

- Designed and manufactured in compliance with the following standards and codes:
- ANSI Z124.2 Standards for Plastic Showers
 - ADA Accessibility Guidelines for Buildings and Facilities
 - ANSI A117.1 A - Accessible and Usable Buildings and Facilities
 - ANSI A117.1 B - Accessible and Usable Buildings and Facilities
 - IPC International Plumbing Code
 - UPC Uniform Plumbing Code

NOTICE OF LIMITATION:



We reserve the right to make revisions without notice in the design of fixtures or in packaging unless this right has specifically been waived at the time the order is accepted.

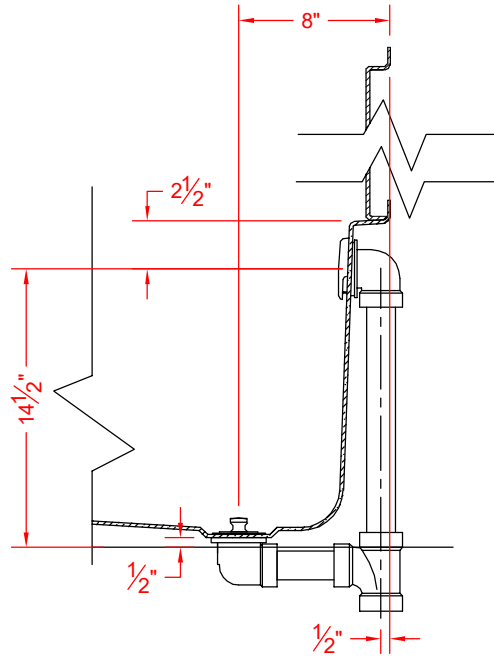

SECTION A-A - SCALE N.T.S.
TUB DRAIN / OVERFLOW DETAIL

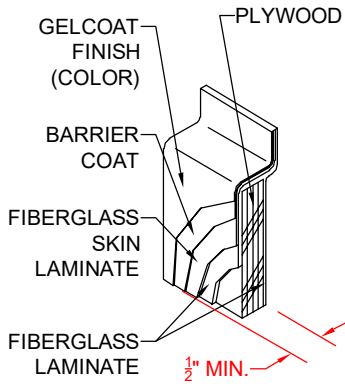

DETAIL CS - SCALE: N.T.S.
CROSS SECTION DETAIL

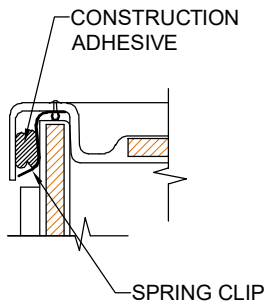

DETAIL CD - SCALE: 3" = 1'-0"
CORNER DETAIL

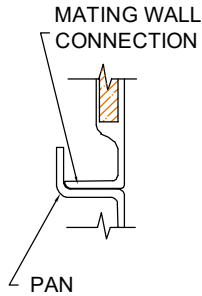

DETAIL PJ - SCALE: 3" = 1'-0"
PAN JOINT DETAIL