

MODEL: 5LBS5436.V2* L/R

REMODELER

*ALL ACCESSORIES OPTIONAL

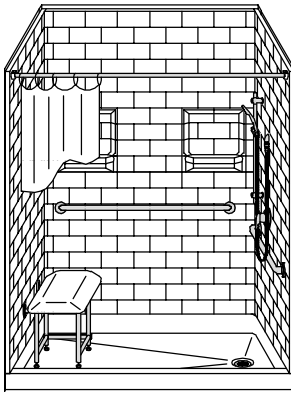

PERSPECTIVE VIEW - N.T.S.
MODEL SHOWN HERE AS:
RIGHT DRAIN

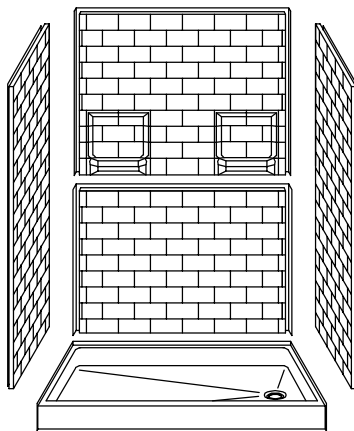

ASSEMBLY VIEW - N.T.S.

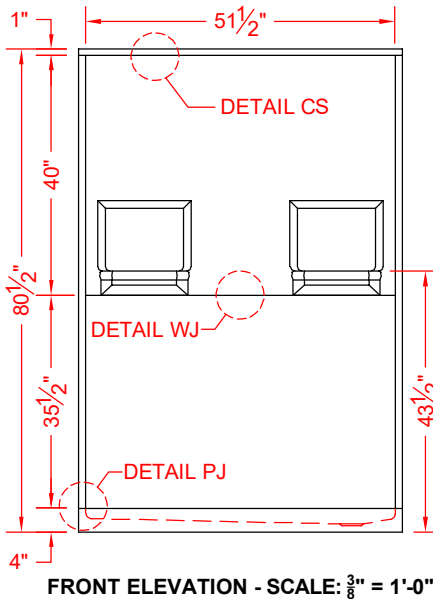
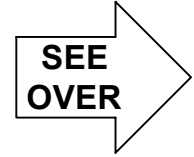
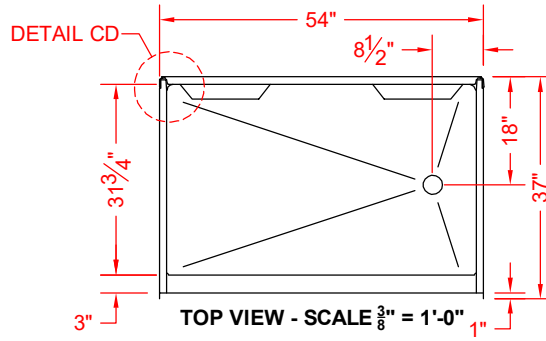

Features:

- Molded, five-piece gelcoat/fiberglass shower module
- "Subway Tile", 4" x 8" simulated tile wall finish, white (standard)
- Integral full wood backing for strength and unlimited accessory placement

* - SEE BACK FOR DETAIL SECTIONS

PRODUCT SPECIFICATIONS:

- Multi-piece shower module shall be constructed of gelcoat/fiberglass with full integral plywood backing
- Rough-In: Stud opening +1/4" -0" Nominal Dimensions.

C.S.I. FORMAT SPECIFICATION TEXT AVAILABLE

PRODUCT INFORMATION:

- Accessories: Polished chrome/satin stainless standard, others available.
- Colors: White as standard, others to match any major fixture manufacturer, also available with sprayable solid surface in many colors

OPTIONAL ACCESSORIES:

INSTALLED BY OTHERS:

- Seat, folding
- Grab bar
- Soap dish
- Mixing valve, pressure-balancing, lever handle, pre-plumbed tree to supply elbow
- Curtain rod brackets
- Curtain and rod
- No-caulk brass drain

CODES:

- Designed and manufactured in compliance with the following standards and codes:
- ANSI Z124.2 Standards for Plastic Showers
- IPC International Plumbing Code
- UPC Uniform Plumbing Code

NOTICE OF LIMITATION:



We reserve the right to make revisions without notice in the design of fixtures or in packaging unless this right has specifically been waived at the time the order is accepted.

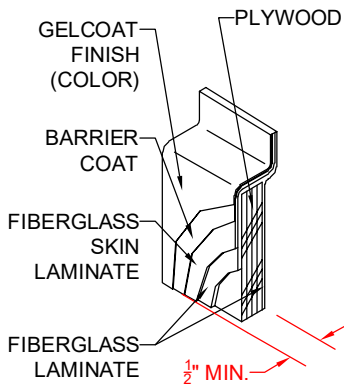

**DETAIL CS - SCALE: N.T.S.
CROSS SECTION DETAIL**

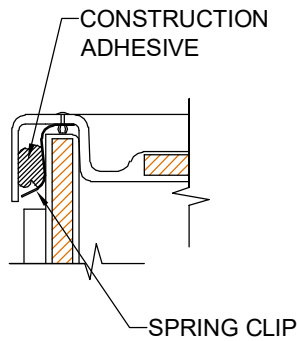

**DETAIL CD - SCALE: 3" = 1'-0"
CORNER DETAIL**

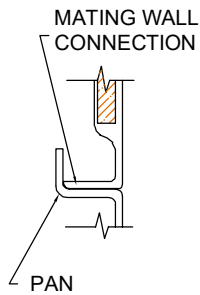

**DETAIL PJ - SCALE: 3" = 1'-0"
PAN JOINT DETAIL**

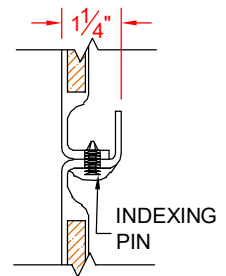

**DETAIL WJ - SCALE: 3" = 1'-0"
WALL JOINT DETAIL**