

# MODEL: 5LBS6030SQ.V2\*

# REMODELER

\*ALL ACCESSORIES OPTIONAL

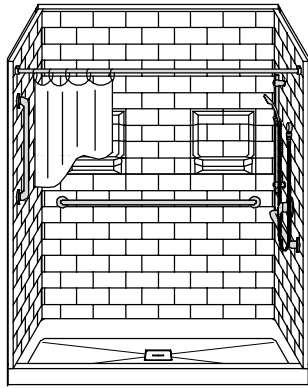

PERSPECTIVE VIEW - N.T.S.  
MODEL SHOWN HERE AS:  
RIGHT PLUMBING

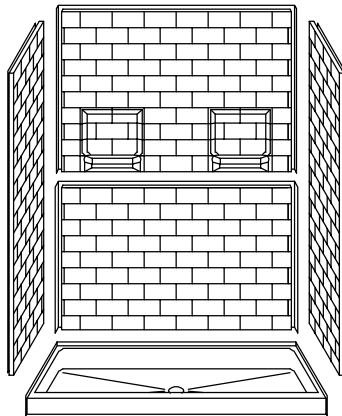

ASSEMBLY VIEW - N.T.S.

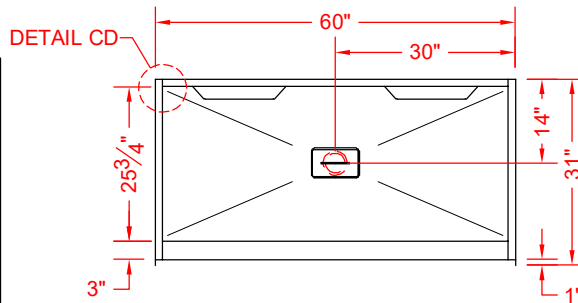

TOP VIEW - SCALE  $\frac{3}{8}'' = 1'-0''$

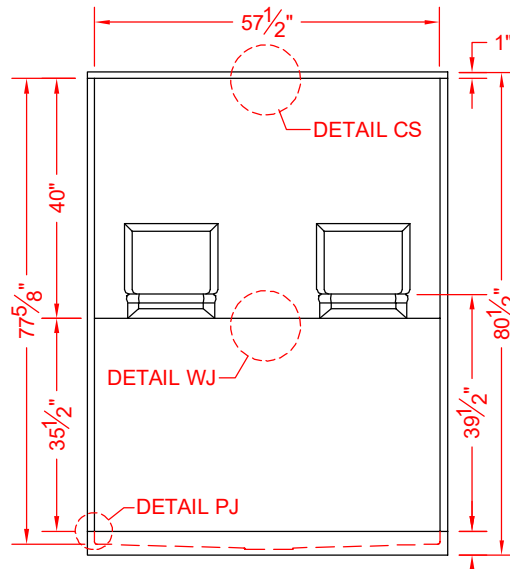
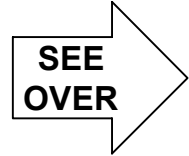

FRONT ELEVATION - SCALE:  $\frac{3}{8}'' = 1'-0''$

## Features:

- Molded, five-piece gelcoat/fiberglass shower module
- "Subway Tile", 4" x 8" simulated tile wall finish, white (standard)
- Integral full wood backing for strength and unlimited accessory placement

\* - SEE BACK FOR DETAIL SECTIONS

## PRODUCT SPECIFICATIONS:

- Multi-piece shower module shall be constructed of gelcoat/fiberglass with full integral plywood backing in the walls
- Door opening: 57-3/8" x 75"
- Rough-In: Stud opening +1/4" -0" Nominal Dimensions.
- C.S.I. FORMAT SPECIFICATION TEXT AVAILABLE

## PRODUCT INFORMATION:

- Accessories: Polished chrome/satin stainless standard, others available.
- Colors: White as standard, others to match any major fixture manufacturer, also available with sprayable solid surface in many colors

## OPTIONAL ACCESSORIES:

### INSTALLED BY OTHERS:

- Seat, folding
- Grab bar
- Soap dish
- Mixing valve, pressure-balancing, lever handle, pre-plumbed tree to supply elbow
- Curtain rod brackets
- Drain grate and No-caulk brass drain (INCLUDED)

## CODES:

- Designed and manufactured in compliance with the following standards and codes:
- ANSI Z124.2 Standards for Plastic Showers
- UPC / IPC compliant when in accordance with Section 408.6 (UPC, 2021)

## NOTICE OF LIMITATION:

- Not I.P.C. International Plumbing Code & U.P.C. Uniform Plumbing Code for new construction



We reserve the right to make revisions without notice in the design of fixtures or in packaging unless this right has specifically been waived at the time the order is accepted.

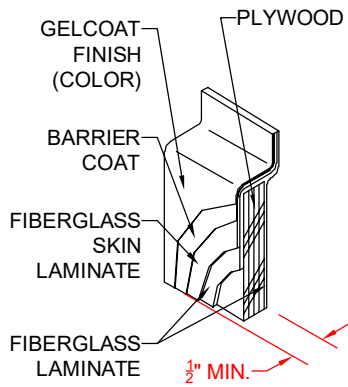

**DETAIL CS - SCALE: N.T.S.**  
**CROSS SECTION DETAIL**

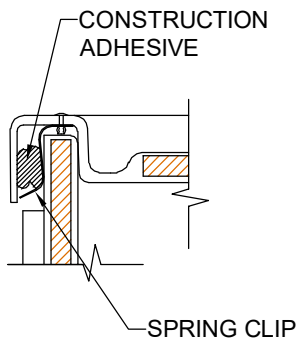

**DETAIL CD - SCALE: 3" = 1'-0"**  
**CORNER DETAIL**

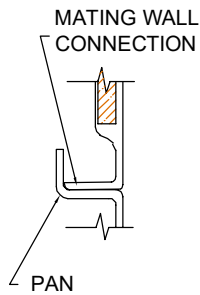

**DETAIL PJ - SCALE: 3" = 1'-0"**  
**PAN JOINT DETAIL**

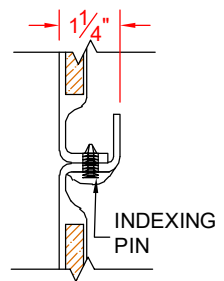

**DETAIL WJ - SCALE: 3" = 1'-0"**  
**WALL JOINT DETAIL**